

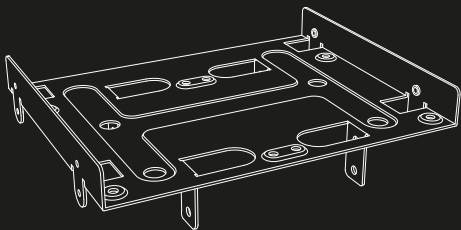

5.25" BayExtension



MANUAL
ENGLISH | DEUTSCH

Package Contents

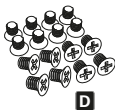
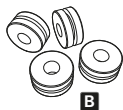
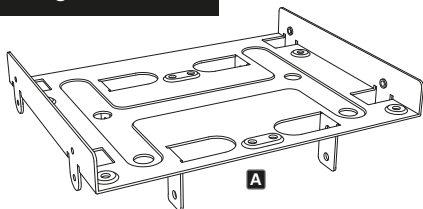

EN

- (A) 1x 5.25" BayExtension
- (B) 4x decouplers
- (C) 4x mounting screws for 3.5" HDD (coarse thread)
- (D) 16x mounting screws for 2.5" HDDs/SSDs (fine thread)
- (E) 4x mounting screws for the mounting frame (fine thread)
- (F) 1x Manual

DE

- (A) 1x 5.25" BayExtension
- (B) 4x Entkoppler
- (C) 4x Montageschrauben für 3,5"-Festplatte (Grobgewinde)
- (D) 16x Montageschrauben für
2,5"-Festplatten/SSDs (Feingewinde)
- (E) 4x Montageschrauben für Einbaurahmen (Feingewinde)
- (F) 1x Anleitung

Mounting 2.5" HDDs/SSDs

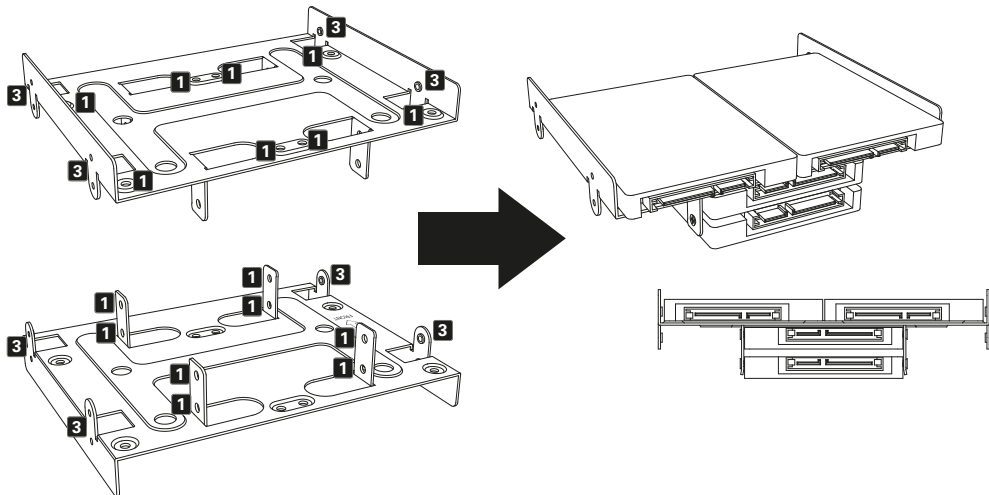

EN 1 - Screw openings for 2.5" HDDs/SSDs
3 - Mounting frame attachment

DE 1 - Schrauböffnungen für 2,5"-Festplatten/SSDs
3 - Befestigung des Einbaurahmens

Mounting 3.5" HDD & 2.5" HDDs/SSDs

- EN**
- 1 - Screw openings for 2.5" HDDs/SSDs
 - 2 - Decoupled attachment for 3.5" HDD
 - 3 - Mounting frame attachment

- DE**
- 1 - Schrauböffnungen für 2,5"-Festplatten/SSDs
 - 2 - Entkoppelte Befestigung für 3,5"-Festplatte
 - 3 - Befestigung des Einbaurahmens

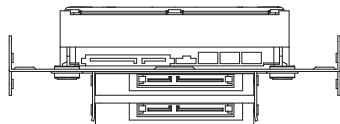
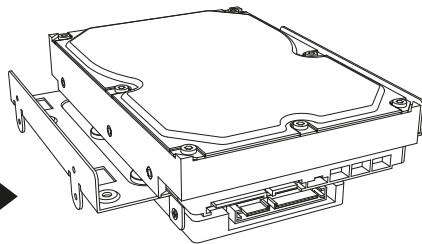
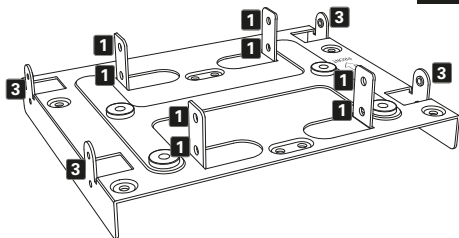
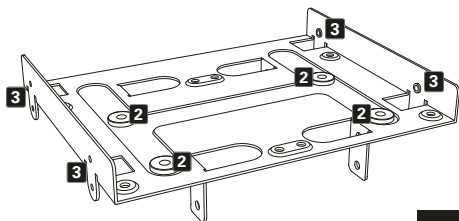

Installing into 5.25" bays

EN

The BayExtension mounting frame can be mounted to standard 5.25" bays of PC cases and is attached with four fine thread screws.

1. Open the PC case.
2. Slide the BayExtension mounting frame with pre-installed HDDs into a 5.25" mounting bay of the case. Refer to the installation guidelines included with the case.
3. Screw the BayExtension mounting frame to the case using the included fine thread screws. Refer to the installation guidelines included with the case.

DE

Der BayExtension-Einbaurahmen wird in Standard-5,25"-Schächte von PC-Gehäusen eingesetzt und mit vier Feingewindeschrauben befestigt.

1. Öffnen Sie das PC-Gehäuse.
2. Schieben Sie den BayExtension-Einbaurahmen mit vorinstallierten Festplatten in einen 5,25"-Einbau-schacht des Gehäuses. Beachten Sie bitte die Hinweise zur Installation, die dem Gehäuse beiliegen.
3. Verschrauben Sie den BayExtension-Einbaurahmen mit den beigelegten Feingewindeschrauben mit dem Gehäuse. Beachten Sie bitte die Hinweise zur Installation, die dem Gehäuse beiliegen.



Follow us on



Sharkoon Technologies GmbH

Grüninger Weg 48

35415 Pohlheim

Germany

© **Sharkoon Technologies 2023**

info@sharkoon.com

www.sharkoon.com