



# SHARK LIGHTS RGB PWM



Manual

# Safety Instructions

This device is to be used as a PC case fan inside a PC case or as a fan for CPU coolers or PC radiators. For your own safety, be sure to follow the instructions below before using the device. If the product is damaged due to improper use or non-compliance with the safety instructions, the manufacturer's guarantee will be void.

## **CAUTION!**

- Be aware of the risk of injury by touching rotating parts. Do not insert any foreign objects between these parts, as this could damage the fan.
- Never bring the fan into contact with moisture or liquids.
- If you need to clean the fan, use a dry cloth.
- Do not use compressed air for cleaning the fan. This could create an electrical charge from the spinning rotor and result in damage to components.
- Only connect the fan to the designated connectors on the mainboard as shown or described in this manual. If necessary, use the operating manual of your mainboard to clearly identify the correct connectors.

# Specifications

## General

■ Fan Speed	500 – 1,700 rpm ± 10 %
■ Bearing Type	Fluid Dynamic Bearing
■ Max. Airflow	89 m <sup>3</sup> /h
■ Max. Air Pressure	1.10 mmH <sub>2</sub> O
■ Max. Noise Level	24.8 dB(A)
■ MTBF	Min. 50,000 Hours
■ Illumination	20x Addressable RGB LED
■ Color Versions	Black, White
■ Weight incl. Fixed Cable	140 g
■ Dimensions (L x W x H)	120 x 120 x 25 mm

## Cable and Connectors

■ Fan Connector	4-Pin PWM
■ LED Connector	4-Pin (5V-D-coded-G)
■ Fan Cable Length	600 mm
■ LED Cable Length	600 mm

## Electrical Specifications

■ Rated Voltage (Fan)	12 V
■ Rated Voltage (LEDs)	5 V
■ Rated Current (Fan)	0.14 A
■ Rated Current (LEDs)	0.9 A
■ Rated Power (Fan)	1.68 W
■ Rated Power (LEDs)	4.5 W
■ Start Voltage	7 V

## Package Contents

■ SHARK Lights RGB PWM, Set with Fan Screws
---

# Connect Fan and LED

**4-Pin PWM  
or 3-Pin  
Fan Connector**

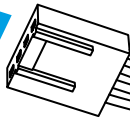

**Mainboard  
Addressable  
RGB Pin Header**

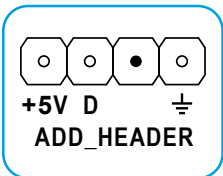
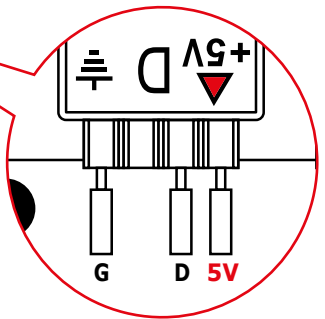
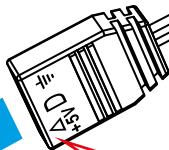

# Install Fan (with screws from back)

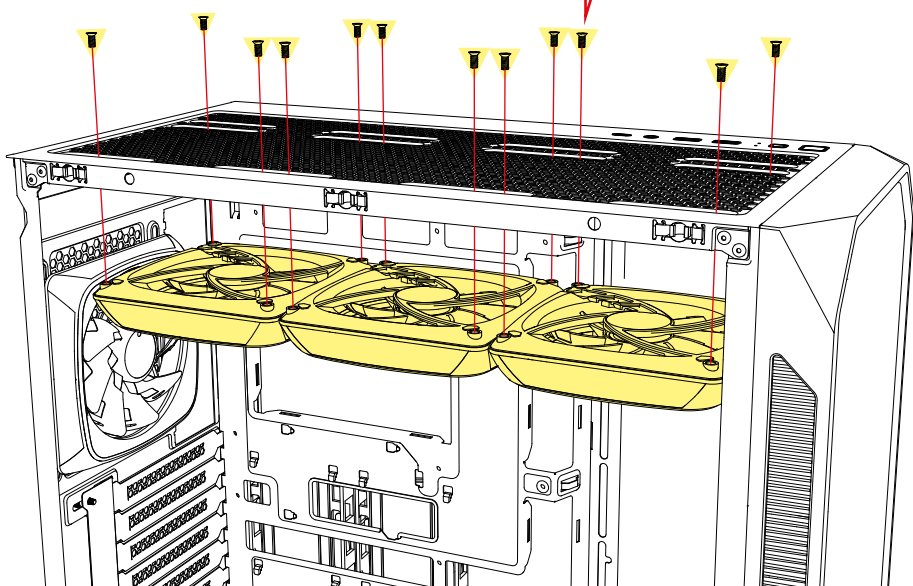
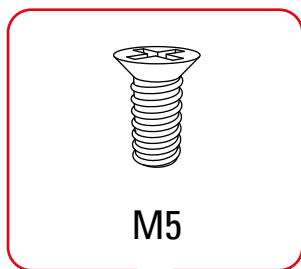

# Install Fan (with screws from front)

 Airflow

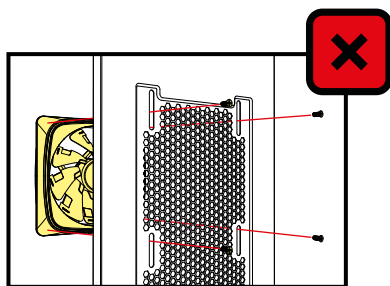
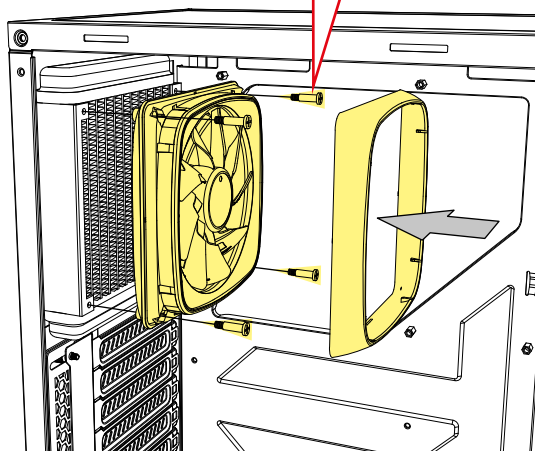
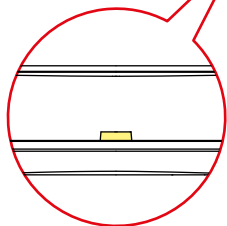
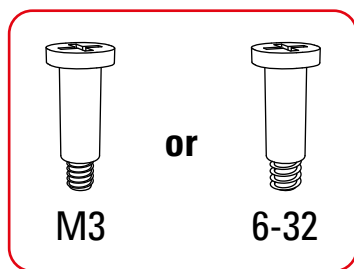
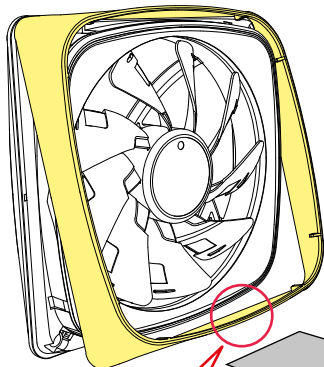

## Legal Disclaimer

For potential loss of data, especially due to inappropriate handling, Sharkoon assumes no liability.

All named products and descriptions are trademarks and/or registered trademarks of the respective manufacturers and are accepted as protected. As a continuing policy of product improvement at Sharkoon, the design and specifications are subject to change without prior notice. National product specifications may vary.

All rights reserved especially (also in extracts) for translation, reprinting, reproduction by copying or other technical means. Infringements will lead to compensation. All rights reserved especially in case of assignation of patent or utility patent. Means of delivery and technical modifications reserved.

## Disposal of your old products

Your product is designed and manufactured with high quality materials and components, which can be recycled and reused.



When this crossed-out wheeled bin symbol is attached to a product, it means the product is covered by the European Directive 2012/19/EU.

Please be informed about the local separate collection system for electrical and electronic products. Please act according to your local rules and do not dispose of your old products with your normal household waste. The correct disposal of your old product will help prevent potential negative consequences to the environment and human health.

**Follow us on social media!**



Facebook



Instagram



YouTube



TikTok



X

**Sharkoon Technologies GmbH**

Grüninger Weg 48

35415 Pohlheim

Germany

© **Sharkoon Technologies 2024**

