



SGK50 S4

GEN2

SKILLER



Manual

Specifications

General

■ Type	Wired Keyboard
■ Switch Technology	
SKILLER SGK50 S4 Gen2 Red	Hot-Swap (Gateron Red)
SKILLER SGK50 S4 Gen2 Brown	Hot-Swap (Gateron Brown)
SKILLER SGK50 S4 Gen2 Yellow	Hot-Swap (Gateron Yellow)
SKILLER SGK50 S4 Gen2 Silver	Hot-Swap (Gateron Silver)
■ Number of Keys	62 ISO
■ Keycap Material	ABS
■ Keycap Legend	Laser
■ Illumination	RGB
■ Adjustable Illumination	✓
■ Lighting Effects	✓
■ Max. Polling Rate	1,000 Hz
■ Form Factor	60 % Layout
■ Onboard Memory for Game Profiles	✓
■ Capacity of Onboard Memory	256 kB
■ Detachable Cable	✓
■ Weight incl. Cable	670 g
■ Weight without Cable	602 g
■ Dimensions (L x W x H)	293 x 103 x 38 mm
■ Supported Operating Systems	Windows

Key Properties

■ Function Keys with Preset Multimedia Actions	✓
■ N-Key Rollover Support	✓
■ On-The-Fly Macro Recording	✓
■ Operating Force	
SKILLER SGK50 S4 Gen2 Red	45 ± 15 g
SKILLER SGK50 S4 Gen2 Brown	55 ± 15 g
SKILLER SGK50 S4 Gen2 Yellow	50 ± 15 g
SKILLER SGK50 S4 Gen2 Silver	45 ± 15 g
■ Switch Properties	
SKILLER SGK50 S4 Gen2 Red	Linear
SKILLER SGK50 S4 Gen2 Brown	Tactile
SKILLER SGK50 S4 Gen2 Yellow	Linear
SKILLER SGK50 S4 Gen2 Silver	Linear
■ Distance to Actuation Point	
SKILLER SGK50 S4 Gen2 Red/ Brown/ Yellow	2.0 ± 0.6 mm
SKILLER SGK50 S4 Gen2 Silver	1.2 ± 0.3 mm
■ Operating Life Cycles of Keys	
SKILLER SGK50 S4 Gen2 Red/ Brown/ Yellow	Min. 50 Million Keystrokes
SKILLER SGK50 S4 Gen2 Silver	Min. 80 Million Keystrokes

Cable and Connectors

■ Connector	USB Type-C
■ Textile-Braided Cable	✓
■ Coiled Cable	✓
■ Cable Length	150 cm
■ Gold-Plated USB Plug	✓

Package Contents

■ SKILLER SGK50 S4 Gen2, Extra Keycaps, Keycap Puller Tool, Switch Puller Tool, USB Cable (150 cm)
--

Safety Instructions

This device is intended as a keyboard for use with a PC. For your own safety, be sure to read the instructions below before using the device. If the product is damaged due to improper use or non-compliance with the safety instructions, the manufacturer's guarantee will be void.

CAUTION!

- Ensure that the device is not damaged before use.
- Only use the device indoors in areas with normal humidity.
- Ensure that the device does not come into contact with moisture or liquids.
- Only clean the device with a dry cloth.
- Connect this device only with compatible, intended cables and only to other compatible, intended devices.
- The device does not contain any components that require maintenance. Opening the keyboard housing will result in the loss of the guarantee.

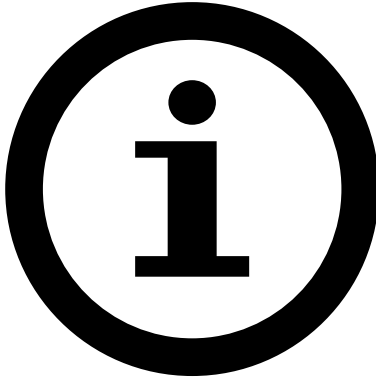

If VIA configuration is not possible through the website at <https://usevia.app/>, please then use the alternative website at <https://via.evove.top/>.

Multimedia Keys

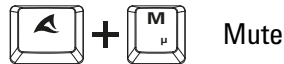
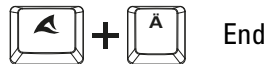
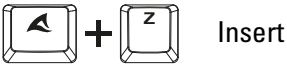
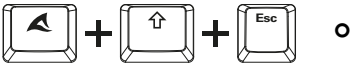
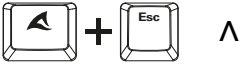
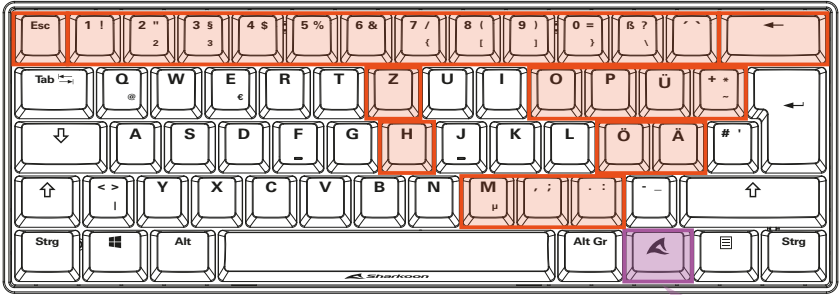

Lighting Effects

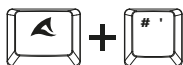
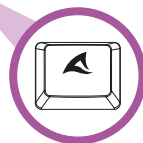
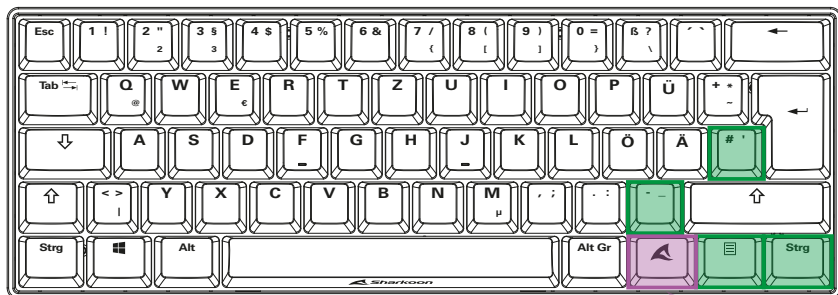

Brightness +



Brightness -

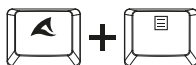

Change Color of Lighting Effect

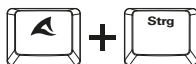

Change Lighting Effect

Macro Keys

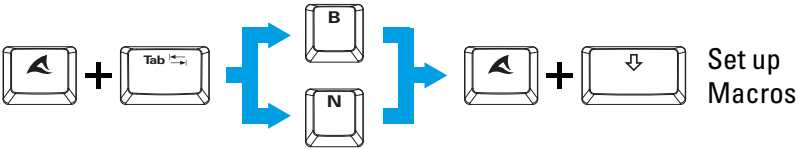
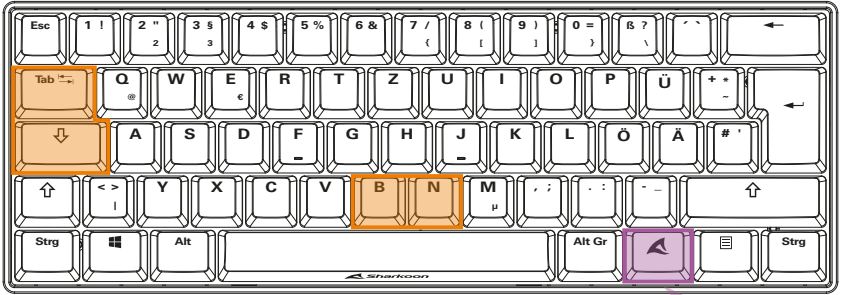

Record Macros

To record macros, first press and hold down the function key and then press the Tab key. Once you have done this, the macro keys **B** and **N** will start flashing. Press and hold down the function key and press one of these two macro keys to select it for macro recording. In the next step, first press and hold down the function key and then press Caps Lock key. The macro key you selected will now start to light up continuously. You can now start entering your macro actions. You can enter up to 16 individual actions. When you have reached the maximum number of actions, the selected macro key starts to flash and the recording is automatically ended. However, if you would like to end the recording before all 16 available macro actions have been entered, first press and hold down the function key and then press the Caps Lock key to end the recording.

Additional Functions

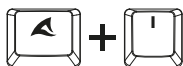
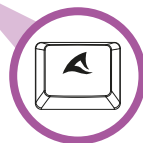
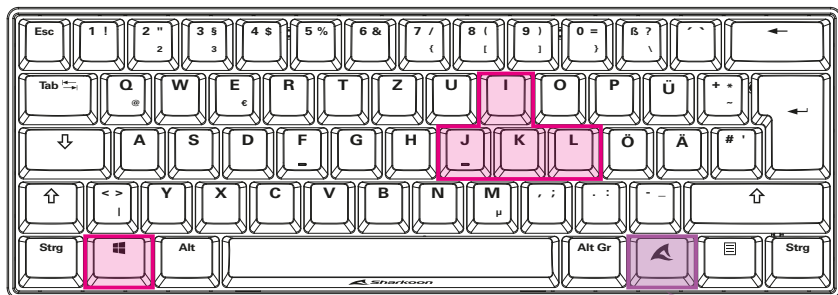

Up Arrow



Left Arrow

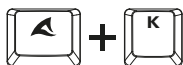

Down Arrow



Right Arrow

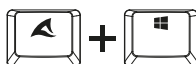

Windows Key Locked

Remove Keycaps

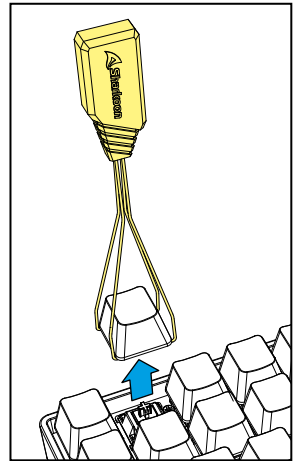
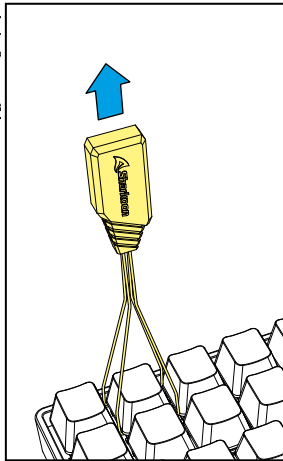
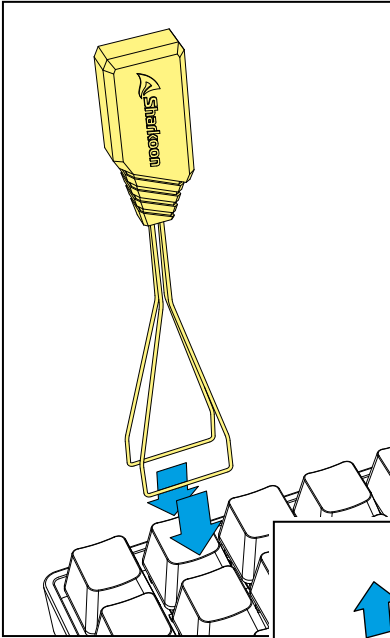

Before removing a switch, first remove the keycap. To do this, place the arms of the keycap puller tool either to the left and right or to the top and bottom of the keycap, and then pull the keycap upwards with careful but constant pressure. Whenever possible, avoid pulling the keycaps from the switch directly with your fingers, as this may damage the switch.

Remove Switches

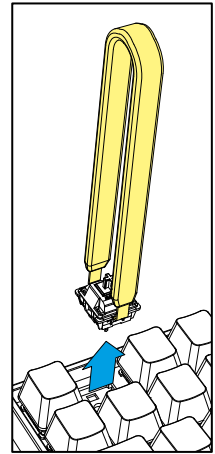
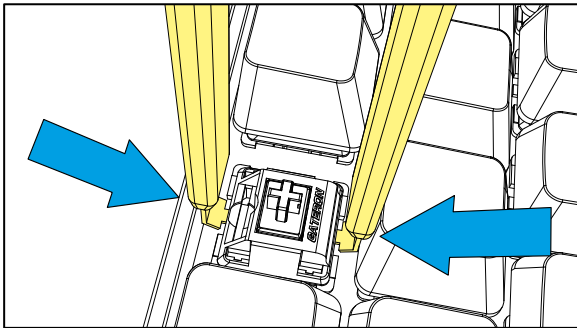
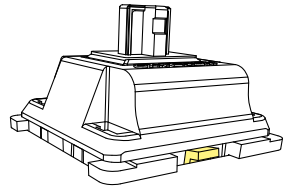
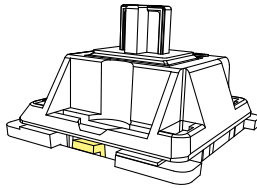
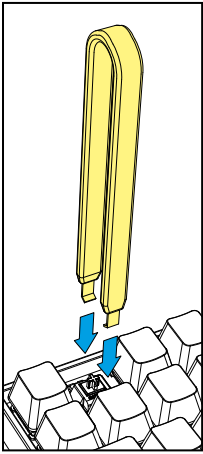

Once you have removed the keycap from the switch, position the switch puller tool correctly on the tabs of the switch. These are positioned to the front and the back of the switch. Before pulling out the switch, make sure that both tabs are securely pressed with the switch puller tool and that the switch can be removed from the socket without resistance. If necessary, remove the adjacent keycaps to allow the switch puller tool sufficient freedom of movement. After you have removed the keycap, press both tabs of the switch with the switch puller tool and then slowly pull the switch out of the socket. Be sure to always pull vertically from the socket with a straight, upward direction. Avoid pulling in a slanted direction, as this can result in damage.

Install Switches

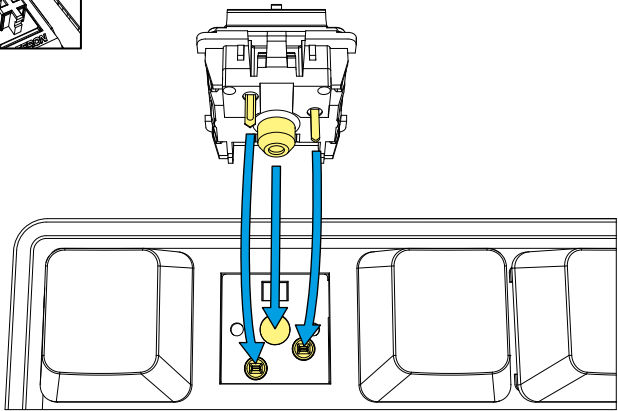
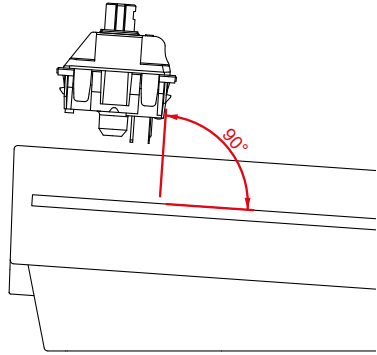
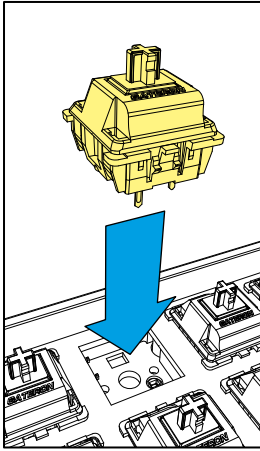

To install the switches, position the switch so that one tab is at the front and the other tab is at the back. Each pin on the underside of the switch should be pointing exactly to its relevant contact in the keyboard socket. Make sure that the switch is led vertically into the socket opening (at a 90-degree angle to the socket). Installing the switch incorrectly can lead to damage or malfunction of the switch. After you have placed the switch in its socket, push very gently on the switch to secure it in place. Make sure that you do not use too much force, as this can damage or destroy fragile components.

Legal Disclaimer

For potential loss of data, especially due to inappropriate handling, Sharkoon assumes no liability.

All named products and descriptions are trademarks and/or registered trademarks of the respective manufacturers and are accepted as protected. As a continuing policy of product improvement at Sharkoon, the design and specifications are subject to change without prior notice. National product specifications may vary.

All rights reserved especially (also in extracts) for translation, reprinting, reproduction by copying or other technical means. Infringements will lead to compensation. All rights reserved especially in case of assignment of patent or utility patent. Means of delivery and technical modifications reserved.

Disposal of your old products

Your product is designed and manufactured with high quality materials and components, which can be recycled and reused.



When this crossed-out wheeled bin symbol is attached to a product, it means the product is covered by the European Directive 2012/19/EU.

Please be informed about the local separate collection system for electrical and electronic products. Please act according to your local rules and do not dispose of your old products with your normal household waste. The correct disposal of your old product will help prevent potential negative consequences to the environment and human health.

Follow us on social media!



Facebook



Instagram



YouTube



TikTok



X

Sharkoon Technologies GmbH

Grüninger Weg 48

35415 Pohlheim

Germany

© **Sharkoon Technologies 2025**

