



FIREGLIDER One



Manual

Safety Instructions

This device is intended as a mouse for use on a PC in dry indoor areas. For your own safety, always follow the instructions below and make sure that the device is not damaged before use. In addition, only use compatible cables and authorized accessories. The manufacturer's guarantee will be void if the product or any installed hardware components are damaged due to improper use or non-compliance with these safety instructions. Should any problems occur with the product, contact our technical customer support at support@sharkoon.com.

- **WARNING!** Choking hazard due to small parts. Danger of strangulation. Keep the device and its cabling away from children under the age of 6 years!
- **WARNING!** Risk of electric shock from electrical parts. Keep the device away from liquids!
- **WARNING!** Epileptic seizures caused by flashing lights. Only use the device in well-lit rooms or, if possible, deactivate the device's lighting! If in doubt, seek medical advice before use!
- **CAUTION!** Damage to joints due to poor body posture. Be aware of the correct ergonomic positioning of your chair and equipment and take regular breaks!
- **DANGER!** Explosion hazard from heat and mechanical impact. Only use the device in normal indoor areas and do not allow it to fall or be knocked or be subject to any other kind of force.
- **WARNING!** Explosion hazard if exposed to liquids or flammable gases. Do not store the device in environments with unusual air pressure or with temperatures above 45 °C.
- **PLEASE NOTE!** Damage to the battery due to deep discharge. Recharge the built-in battery at least occasionally!
- **PLEASE NOTE!** The power output of the charger should be at least 0.2 watts, the minimum required by this wireless device. To achieve the maximum charging rate for this device, the output power of the charger should be at least 5.0 watts.

Specifications

General:

■ Type:	Dual Mode
■ Wireless Communication:	2.4 GHz
■ Max. Wireless Range:	10 m
■ Max. DPI/CPI:	12,000
■ Min. DPI/CPI:	400
■ Sensor:	Optical
■ Chip:	PixArt PAW3311
■ Onboard Memory for Game Profiles:	✓
■ Capacity of Onboard Memory:	512 kB
■ Max. Polling Rate:	1,000 Hz
■ Lift-Off Distance:	2 mm
■ Frames Per Second:	Self-Adjusting
■ Inches Per Second:	300
■ Max. Acceleration:	35 g
■ Mouse Feet:	3, PTFE
■ Color Versions:	Black, White
■ Weight without Cable:	50 g
■ Dimensions (L x W x H):	127.5 x 64 x 40 mm
■ Supported Operating Systems:	Windows

Button Properties:

■ Number of Buttons:	5
■ Main Button Switches:	Huano
■ Operating Life Cycles of Buttons:	Min. 20 Million Clicks

DPI Properties:

■ DPI Levels:	400; 800; 1,600; 3,200; 6,400; 12,000
■ DPI Switch:	✓
■ DPI Indicator:	LED

Battery Properties:

■ Type:	Lithium-Ion
■ Capacity:	300 mAh
■ Battery Life:	Max. 100 Hours
■ Recharge Options:	Wired (USB)

Cable and Connectors:

■ Connector:	USB-C to USB-A
■ Textile-Braided Cable:	✓
■ Cable Length:	180 cm

Package Contents:

■ FIREGLIDER One, Additional Set of Mouse Feet, USB Power and Data Cable, USB Nano Receiver

Overview

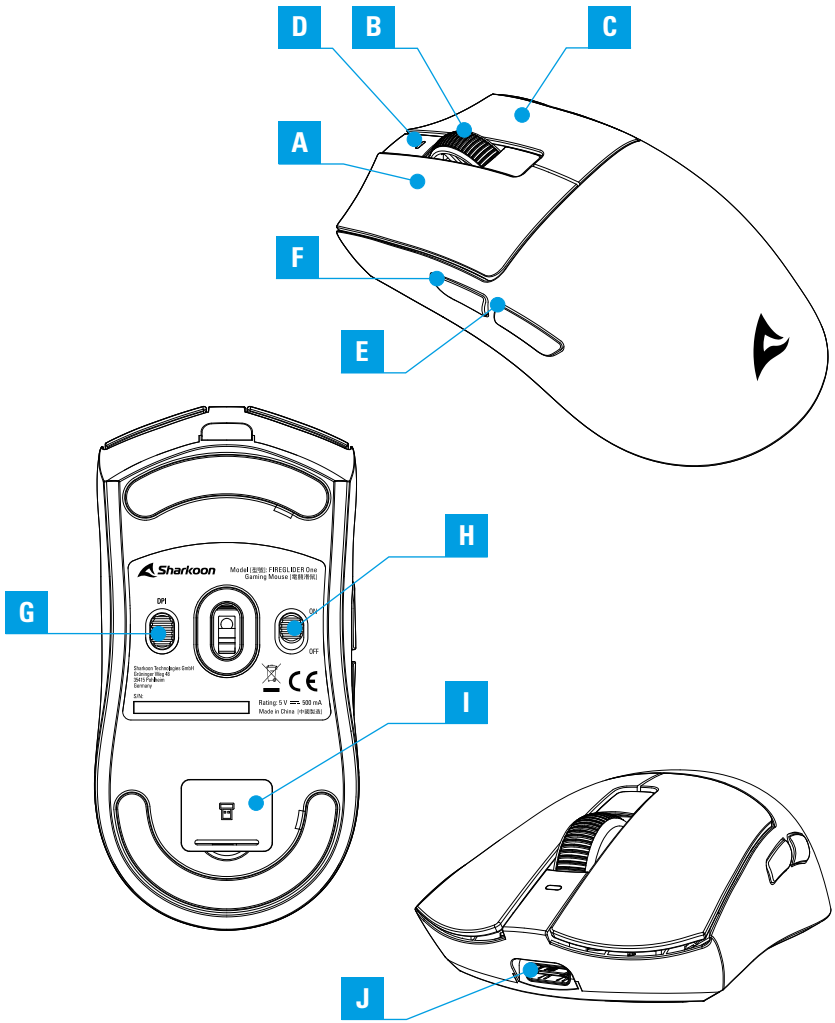

- A** Left Mouse Button
- B** Scroll Wheel
- C** Right Mouse Button
- D** DPI and battery status indicator
- E** Thumb Button 2

- F** Thumb Button 1
- G** DPI Switch
- H** Mode Switch
- I** Compartment for USB Nano Receiver
- J** USB Connector

Remove USB Nano Receiver

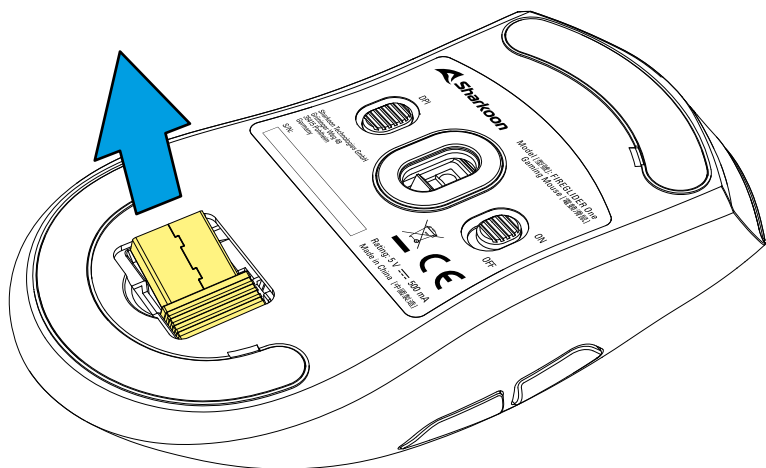
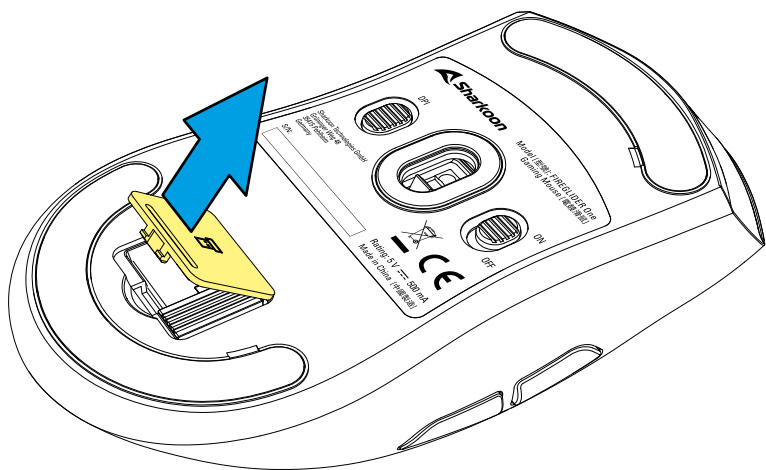

Remove Protection Foil

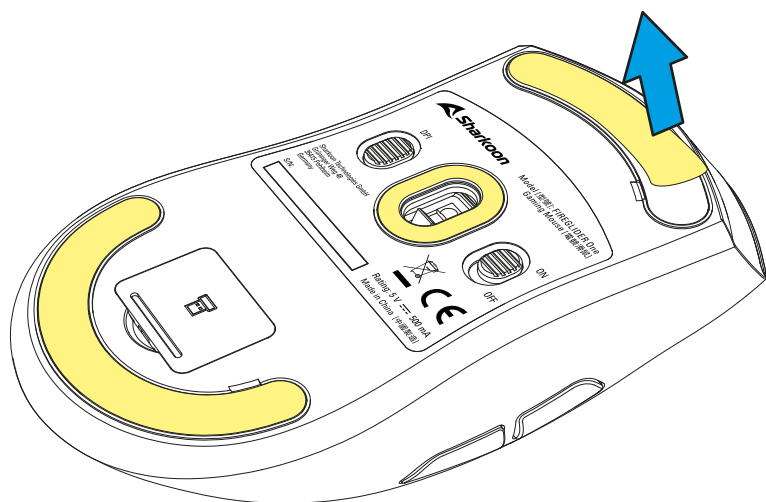

Connect via USB Nano Receiver

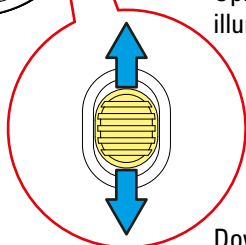
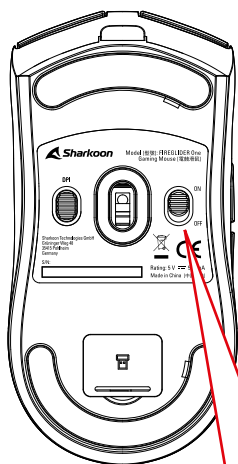
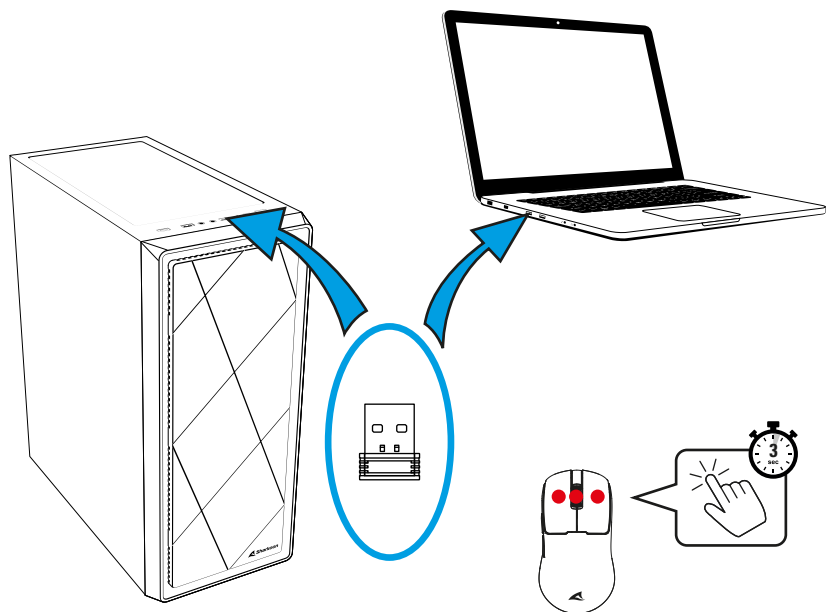

Up: Wireless,
illumination on

Down: Wireless,
illumination off

Connect via Cable

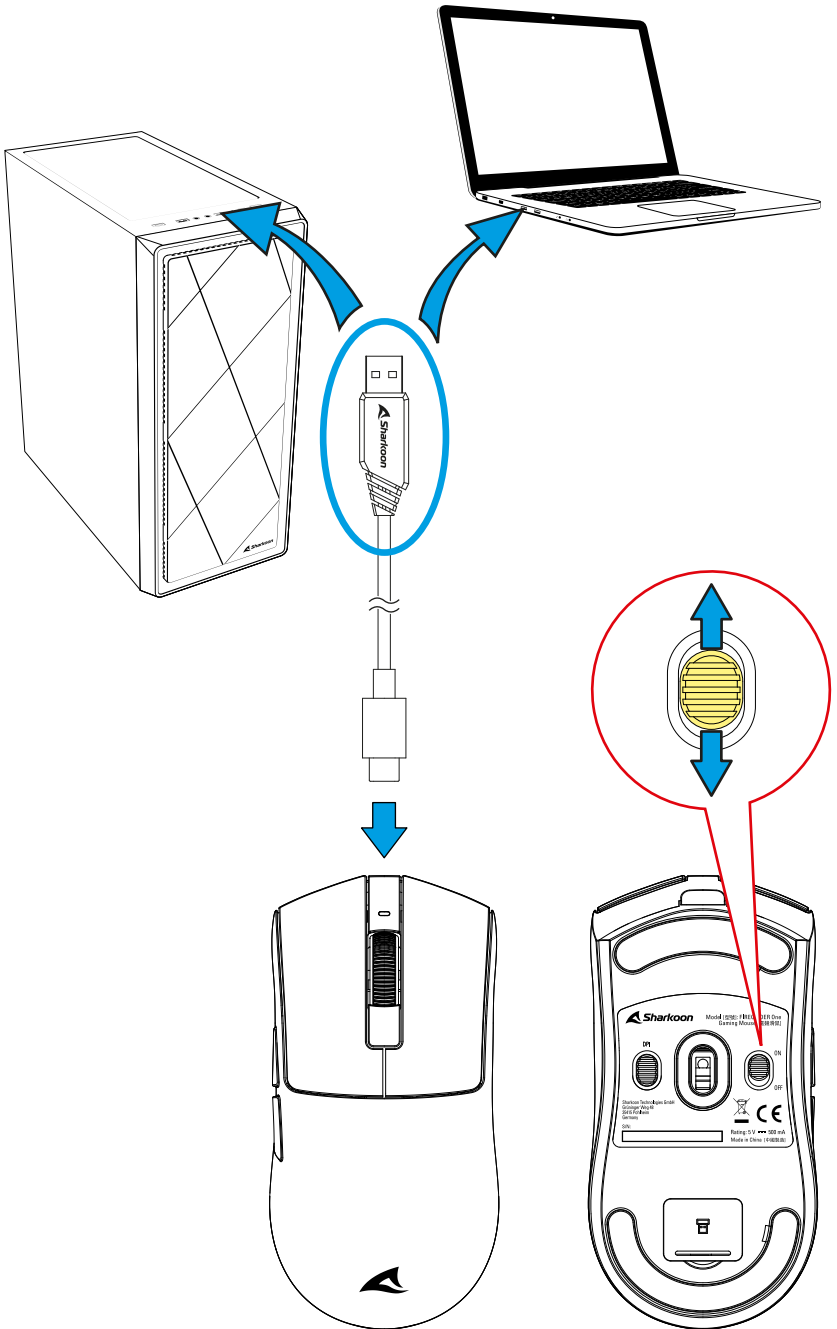

Charge the Mouse

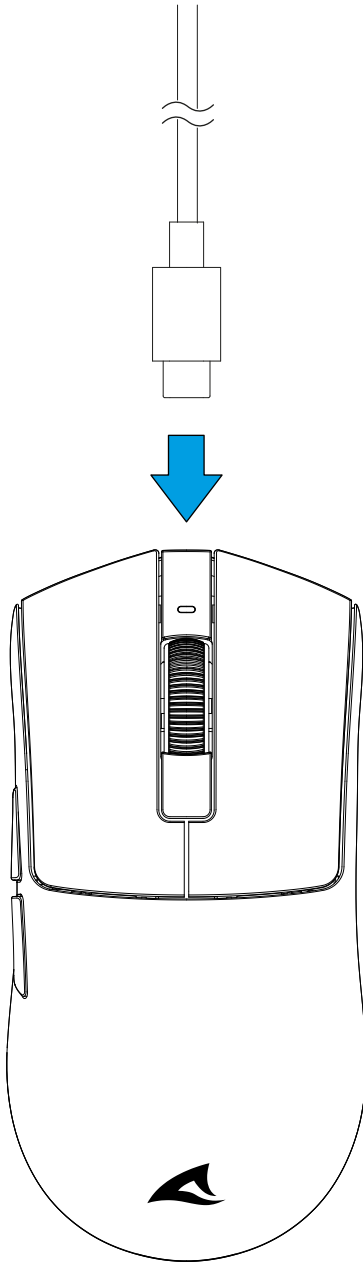

See Battery Status

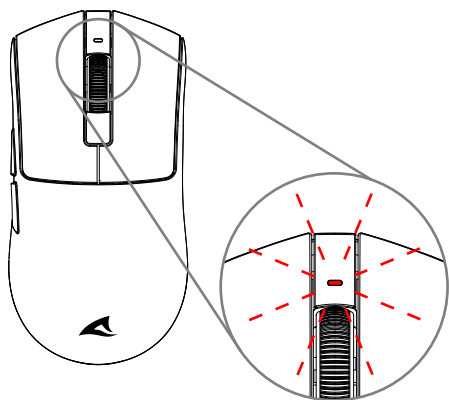

Low battery level

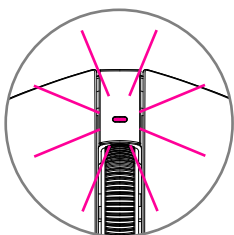

Charging

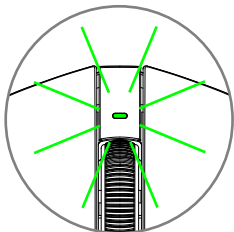

Charged

Select DPI Levels

Pressing the DPI selection button cycles through the DPI levels; the DPI and battery status indicator briefly flashes in the color shown here:

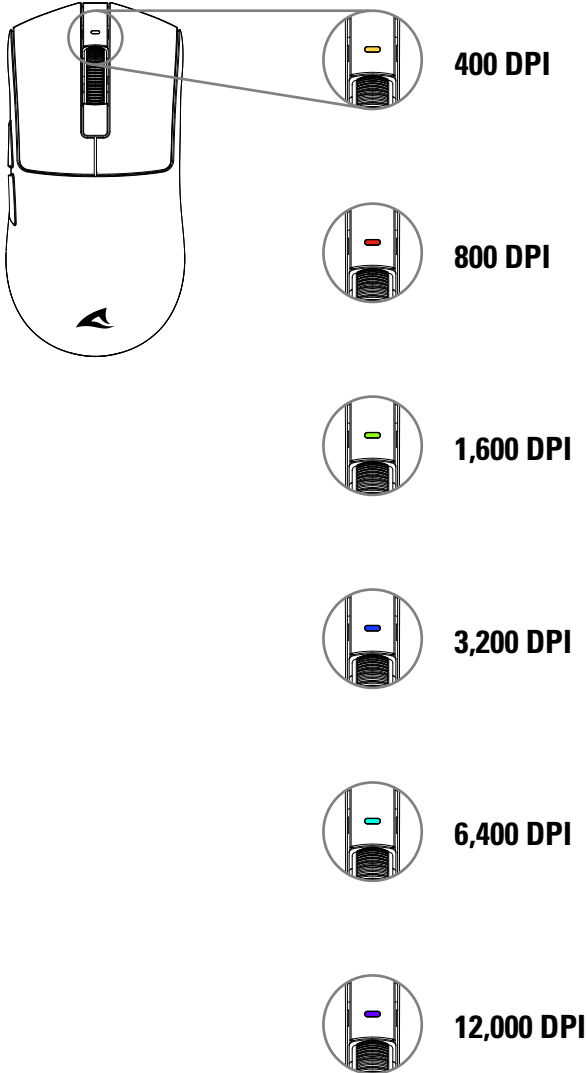

Recycle Battery

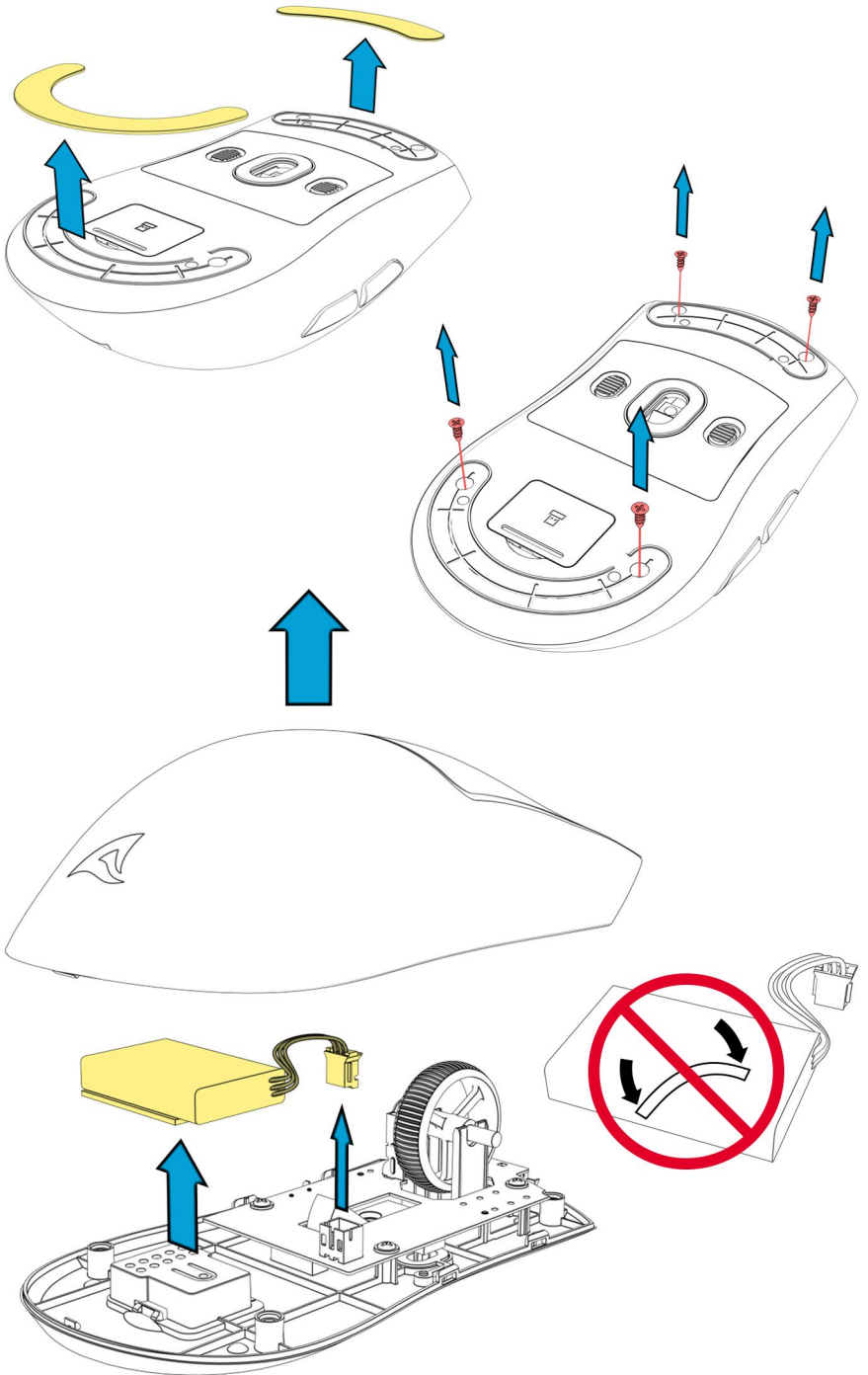

EU Declaration of Conformity

Sharkoon Technologies GmbH hereby declares that this device complies with the RoHS (2011/65/EU) and R.E.D (2014/53/EU) directives.

The full EU Declaration of Conformity is available on the website

https://www.sharkoon.com/Download/Gaming/Mouse/FIREGLIDER_One/CE.zip

Frequency Range: 2.400 GHz – 2.480 GHz

EIRP Transmit Power: ≤ 2 dBm

Operating Temperature: -10 °C – $+40$ °C

Legal Disclaimer

For potential loss of data, especially due to inappropriate handling, Sharkoon assumes no liability.

All named products and descriptions are trademarks and/or registered trademarks of the respective manufacturers and are accepted as protected. As a continuing policy of product improvement at Sharkoon, the design and specifications are subject to change without prior notice. National product specifications may vary.

All rights reserved especially (also in extracts) for translation, reprinting, reproduction by copying or other technical means. Infringements will lead to compensation. All rights reserved especially in case of assignation of patent or utility patent. Means of delivery and technical modifications reserved.

Disposal of your old products

Your product is designed and manufactured with high quality materials and components, which can be recycled and reused.



When this crossed-out wheeled bin symbol is attached to a product, it means the product is covered by the European Directive 2012/19/EU.

Dispose of waste electrical and electronic equipment in accordance with the regulations in your country and do not dispose of your old electrical and electronic equipment with normal household waste. Rechargeable and single-use batteries must be disposed of separately from other waste. The correct disposal of your old product will help prevent potential negative consequences to the environment and human health.

Follow us on social media!



Facebook



Instagram



YouTube



TikTok



X

Sharkoon Technologies GmbH

Grüninger Weg 48

35415 Pohlheim

Germany

© Sharkoon Technologies 2025

